

SIXPACK

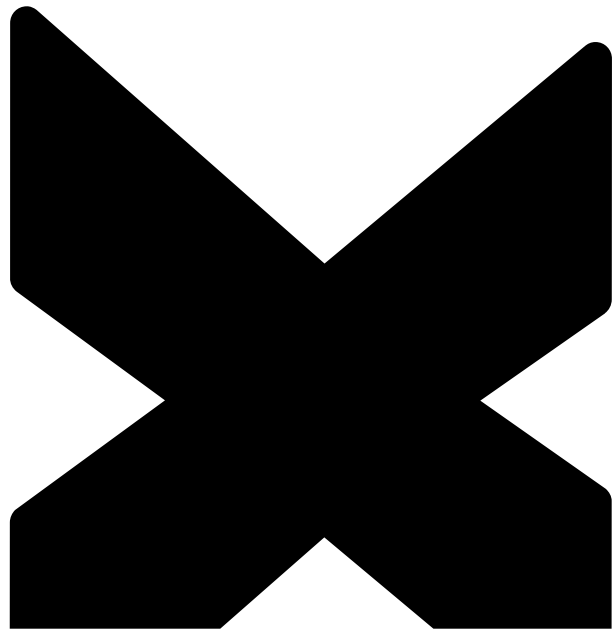

EN

Kamikaze

Menace

Vertic 35

User Manual

Stem Ahead

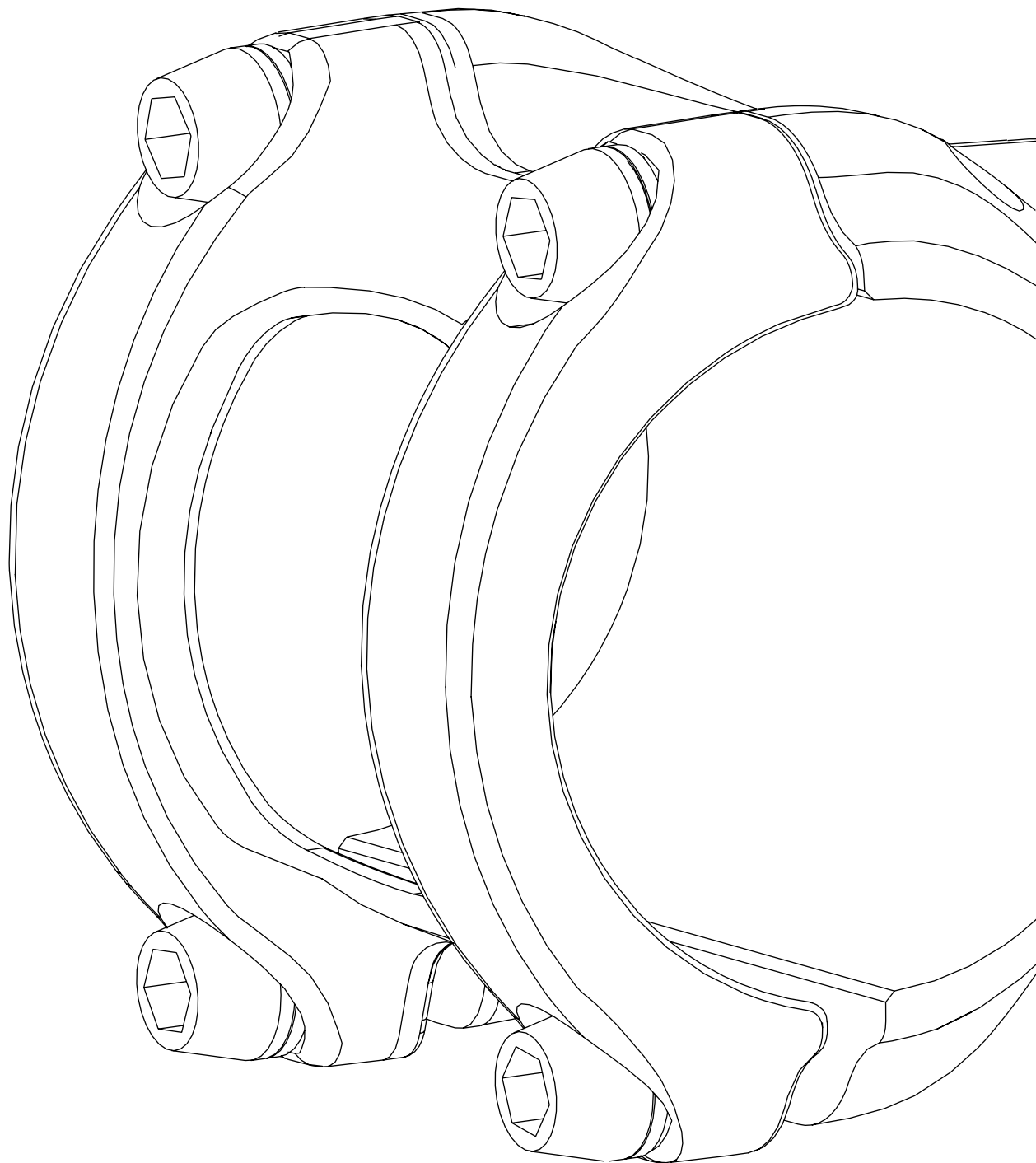

Content

Intended use	6
Compatibility	6
Guarantee / Crash Replacement	7
Mounting the stem	8
After a crash	12
Care and maintenance	13



Intended use

Sixpack components are designed for the following categories according to ASTM F2043:

- VERTIC and MENACE: **Category 4**
- MILLENIUM and KAMIKAZE: **Category 5**

Category 4: Use in rough terrain and jumps up to 122 cm

Category 4 includes the use of bikes and their components under the conditions of categories 1, 2 and 3 as well as in very rough and partially blocked terrain with steeper sections and higher speeds. Regular, moderate jumps pose no problem for experienced riders when using these bikes.

Extended and regular use in bike parks and when tackling “North Shore” sections should be avoided. Due to increased stresses, these bikes should be checked for damage after every ride. Full suspension bikes with mid-level travel are typical in this category.

Category 5: Extreme use (downhill, freeride, dirt)

Category 5 includes the use of bikes and their components under the conditions of categories 1, 2, 3 and 4 as well as in demanding, heavily blocked and extremely steep terrain, which can only be mastered by technically experienced and very well trained riders. In this category, big jumps are to be expected as well as intensive use in bike parks or on downhill tracks. With these bikes it is essential to ensure that after each ride an intensive check for possible damage is carried out. Pre-damages can lead to failure even if further stresses are significantly lower. A regular replacement of safety-relevant components should also be considered. Wearing appropriate protective gear is absolutely essential. Long travel full-suspension bikes but also dirt bikes characterize this category.

Compatibility

The clamping surface of the handlebar must be equal to or wider than that of the stem.

The stem must not be modified or altered.

Guarantee / Crash Replacement

The statutory warranty applies to all components. If damage occurs outside the warranty, contact us and we try to find an individual solution.

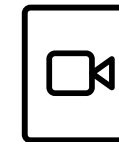

Assembly video

Scan the code and watch the video.



Mounting the stem

DANGER

Danger due to incorrectly mounted

- The tightening torque of the stem must not be exceeded.
- Additionally, check the handlebar manufacturer's instructions for specific provisions. In particular, the tightening torque may be restricted by the handlebar manufacturer.
- The assembly sequence must be observed. The clamping points labeled "NO GAP" must be tightened first.
- Do not use grease or other lubricants to mount the stem.

- 1 Clean and degrease the clamping surface of the handlebar and stem.
- 2 Put the stem on the steerer tube.
The stem must protrude 2 to 3 mm above the steerer tube.

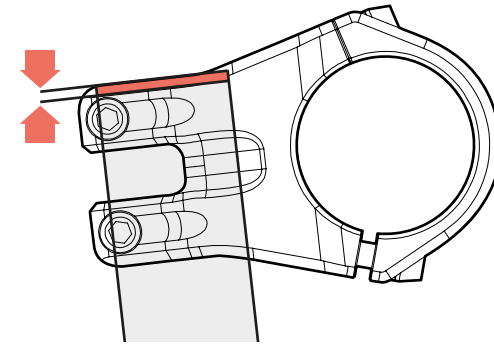

- 3 Install the headset cap and lightly tighten the headset clearance adjustment screw.
- 4 Completely unscrew the upper and lower screws of the handlebar clamp and remove the handlebar clamp.



Mounting the stem

- 5** Attach the handlebar and the handlebar clamp and turn the handlebar clamp screws in slightly.

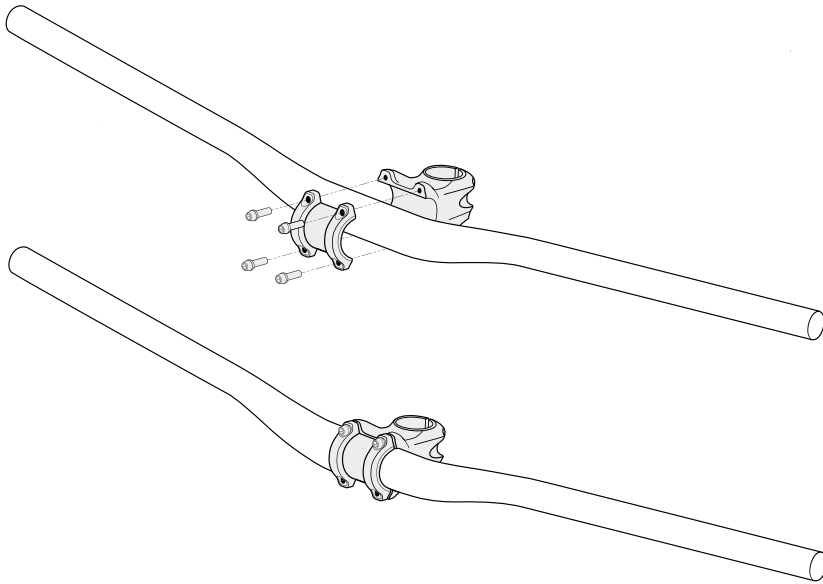

- 6** Adjust the handlebar according to your needs.

- 7** First tighten the upper screws of the handlebar clamp (A) with 6 Nm.

There must be no gap between stem and handlebar clamp on the top side of the stem!

- 8** Then tighten the lower screws of the handlebar clamp (B) with 6 Nm. It is possible that the handlebar manufacturer specifies a lower torque.

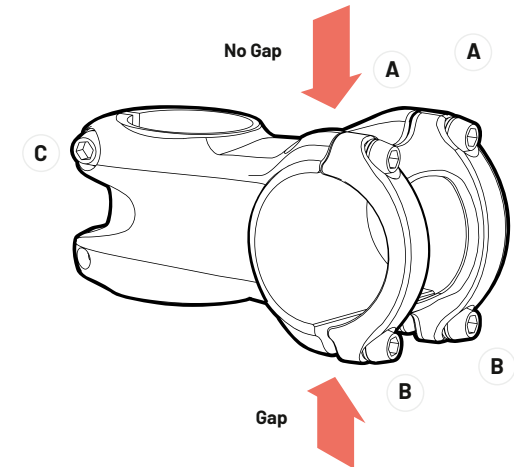
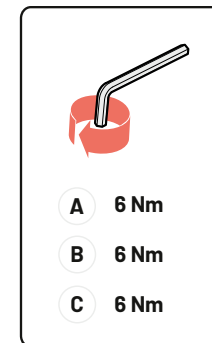

- 9** Adjust the headset clearance according to the headset manufacturer's specifications.

- 10** Tighten the screws of the steerer tube clamp (C) alternately until the torque of 6 Nm is reached.

- 11** Check that the handlebar is securely fastened. If you have any doubts or questions, you must seek the help of a trained bicycle mechanic or the Sixpack Service!



After a crash



DANGER

Risk of accident due to damaged or broken stem!

- Replace your stem in case of deformations or deep scratches!
- After a heavy crash, overstressing of the stem and thus a reduction in mechanical strength is possible. This can lead to subsequent stem failure and serious accidents with high potential for injury or death.
- We recommend replacing the stem after heavy crashes.
- If you have any doubts or questions, you must seek the help of a trained bicycle mechanic or the Sixpack Service!werden.

Care and maintenance

The following activities must be carried out regularly:

- Check the tightening torque of all screws regularly and retighten to the specific torque if necessary.
- Clean stem regularly with clear water or mild detergent. Observe the application recommendations of the cleaner used.
- Check stem regularly for cracks, deformation, discoloration or other signs of damage. A damaged stem must not be used any further!
- If you have any doubts or questions, you must seek the help of a trained bicycle mechanic or the Sixpack Service!